

Position indicators freely programmable

Item description/product images

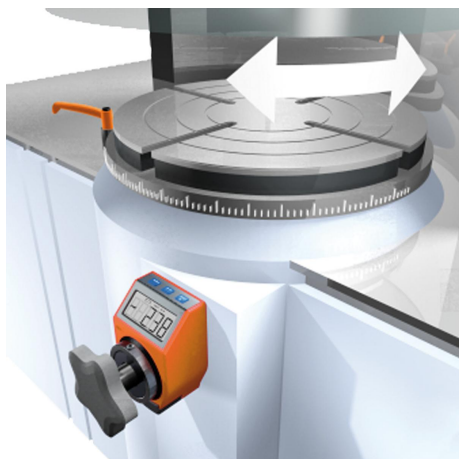

for electrics



Description

Material:

Housing plastic.
Hollow shaft steel.
Screen LCD display.
Grub screw steel.

Version:

Hollow shaft black oxidised.
Grub screw black.

Note:

The electronic position indicators offer diverse opportunities compared to mechanical position indicators because they display angles as well as uncommon spindle pitches and record each fraction of spindle movement.

* Freely programmable parameters using the programming software K0411.09.

Technical data:

- LCD Display with 5 digits
- Digit size approx. 8 mm
- Display range from -19999 ... 99999
- Hollow shaft \varnothing 14 H7 mm
- Operating temperature -10 °C to +60 °C
- Storage temperature -30 °C to +80 °C
- Revolution max. 600 rpm
- Lithium battery button cell 3V, type CR 2032. service life ca. 2 years
- Vibration-resistance acc. to DIN IEC 68-2-6 10 g / (5 ... 150 Hz), 20 g / (100 ... 2000 Hz)
- Shock-resistance acc. to DIN IEC 68-2-27 30 g / 15 ms
- EMC DIN EN 61000-4-2; DIN EN 61000-4-4
- Protection IP 51

Features:

- indicated value and decimal point freely programmable
- linear or angle mode
- function key for zero-point position
- function key for switching between the absolute dimension and chain dimension
- programming of an offset value directly at the device
- easy battery change

Accessory:

- reducing bushes K0412
- programming software K0411.09

Position indicators freely programmable

Item description/product images

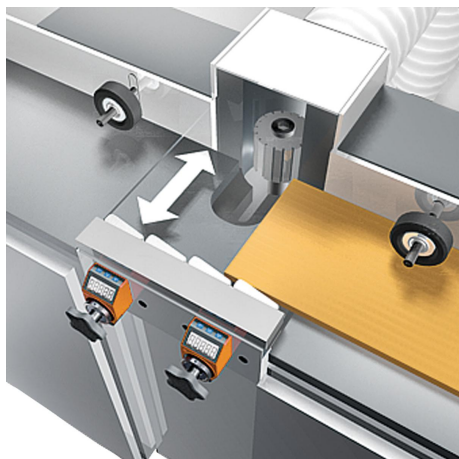



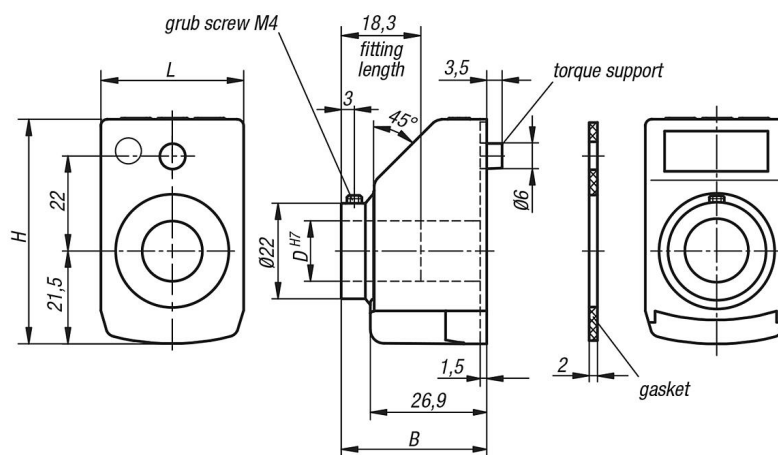









Drawings



Position indicators freely programmable

Drawings

Order code:

K0771. 					
Indicator after one rotation:	Decimal point position:	Assembly position:	Count direction:	Colour:	Zero-point position:
e.g. K0771.0200021120 Please indicate here which value is to be displayed after one rotation (this is usually the spindle pitch). Important: Please note the decimal point position!	e.g. K0771.0200021120 Please indicate here how many decimal places you require. 0 = 00000 1 = 0000.0 2 = 000.00 3 = 00.000	e.g. K0771.0200021120 1 = Mounting position for horizontal spindle 3 = Mounting position for vertical spindle	e.g. K0771.0200021120 1 = clockwise (ascending values) 2 = anticlockwise (ascending values)	e.g. K0771.0200021120 1 = orange 2 = black	e.g. K0771.0200021120 0 = directly 5 = delayed by 5 sec.
		 			
Angle mode: (resolution 0.1°) If you want the display to be in angle mode, enter 03600. The display in angle mode is 03600 after one rotation and returns to 00000 for the next rotation.	Angle mode: If you want the display to be in angle mode, the decimal point is best put in position 1. This means the display shows the value 0360.0 after one rotation.				The Zero-point position can be delayed by 5 sec. by means of a parameter, in order to avoid accidental zero setting.

Overview of items

Position indicators programmed

Order No.	Version 1	Version 2	B	D	H	L
K0771.	digital	programmed	33,6	14	52	33

Position indicators not programmed*

Order No.	Assembly position	Main colour	Version 2	Order No. software
K0771.11	1	orange	freely programmable	K0411.09
K0771.12	1	black	freely programmable	K0411.09
K0771.31	3	orange	freely programmable	K0411.09
K0771.32	3	black	freely programmable	K0411.09