

# Technical Information

## Quarter-turn latches K2256 and clamping pins K2257

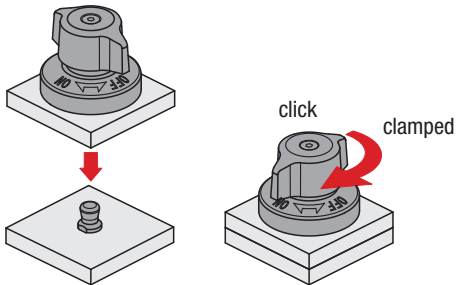

### 1. Application:



Check that the rotary knob is in the "OFF" position.  
Set the quarter-turn latch over the clamping pin and turn the rotary knob to the "ON" position.  
When fully clamped, a click sound is heard.

### 2. Function:

Four balls hold the clamping pin and clamp the plates together.

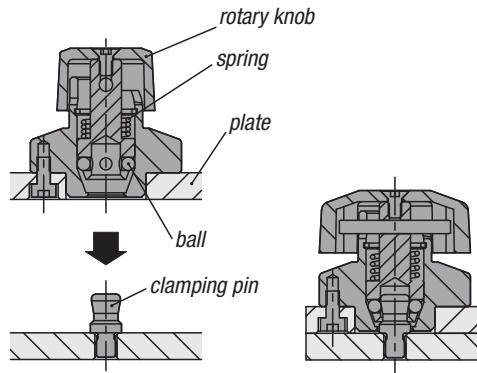

### Production tolerances:

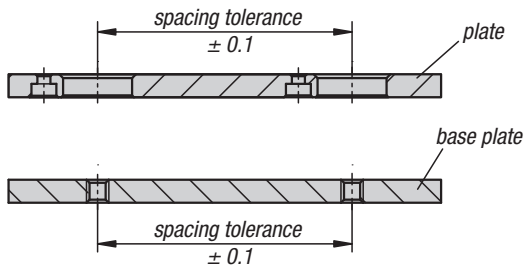

### Repeat accuracy:

A higher repeat accuracy can be achieved with the aid of additional locating pins (not supplied).

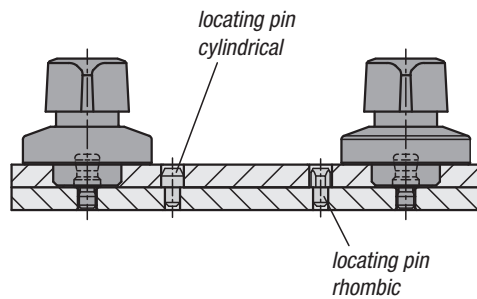

### Application examples:

#### Replacement of the plates

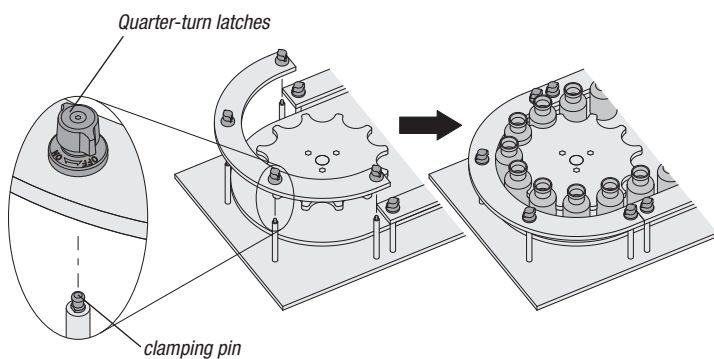

#### Lifting the suction pads

