

Collets for external clamping

Item description/product images



Description

Material:

High-strength aluminium alloy

Version:

blue anodised.

Note:

Collets for clamping external contours.

The contour of the workpiece to be held is machined into the collet. Free-form and asymmetrical contours can be held.

The collet mechanism enables a secure clamping of the workpiece.

Clamping travel per collet segment (8x) max. 0.15 mm.

Workpiece repeat accuracy: ± 0.03 .

Collet repeat accuracy: ± 0.02 .

Matching adaptor K1183.

Drawings

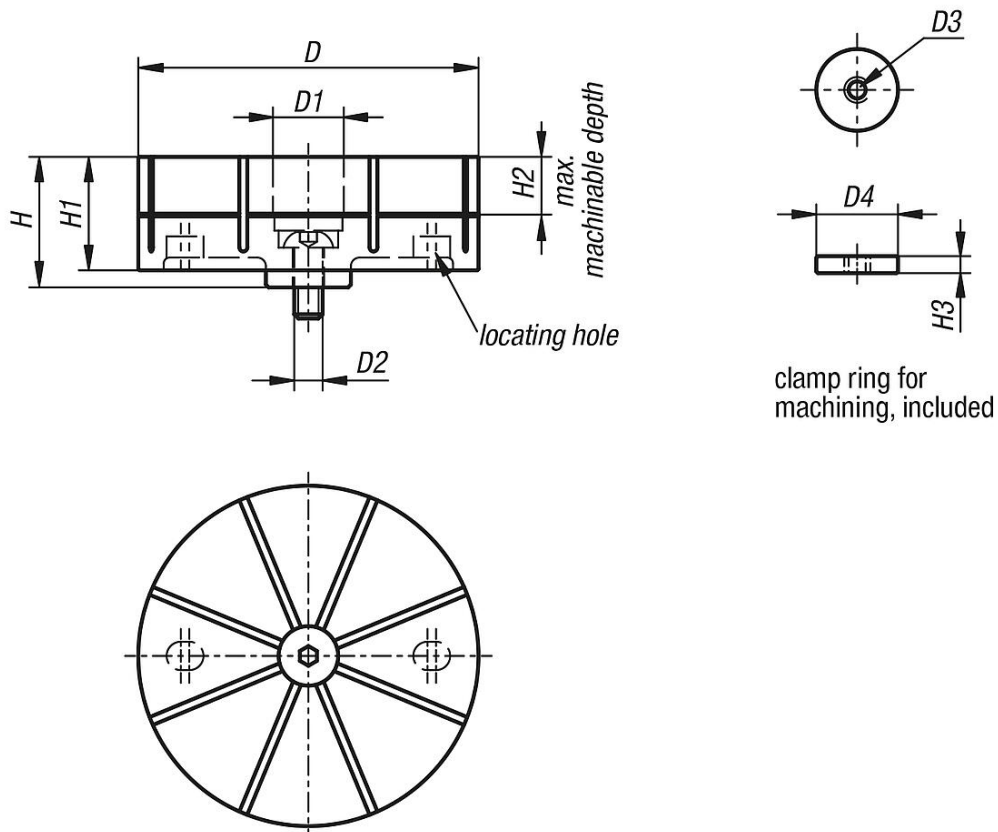

Collets for external clamping

Drawings

1. Mounting collet:

- Insert an O-ring into the groove on the top face of the clamp base.
- Set a collet on the base making sure the locating pins fit into the locating holes on the underside of the collet. Secure the collet using a buttonhead hex socket screw.

Note:

Before mounting the collet, ensure the cam cylinder is fully loosened by turning the tightening screw counterclockwise until it stops.

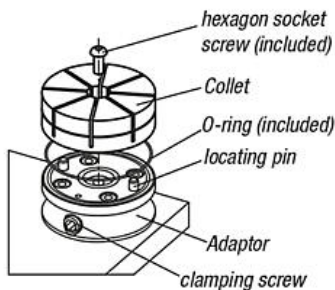

2. Machining collet:

2.1

Place the clamp ring in the centre of the collet. (Use a screw as an insertion aid)

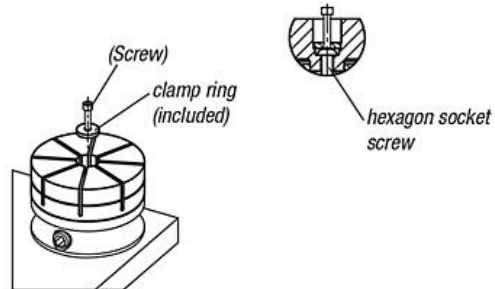

2.2

Tighten the cam cylinder to clamp the clamp ring (recommended torque: 15Nm). Remove the screw from the clamp ring before machining.

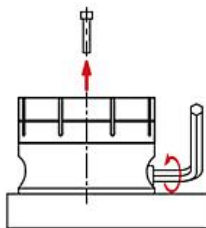

2.3

Machine the contour of the part that is to be held into the collet.

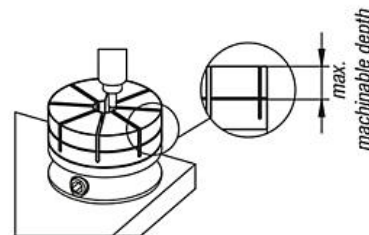

Note:

Do not machine the contour deeper than the permitted depth.

3. Mounting workpiece:

- Loosen the cam cylinder and remove the clamp ring.
- Place the workpiece in the contour and re-tighten the cam cylinder.

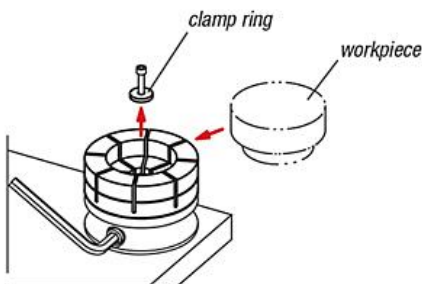

Performance curve

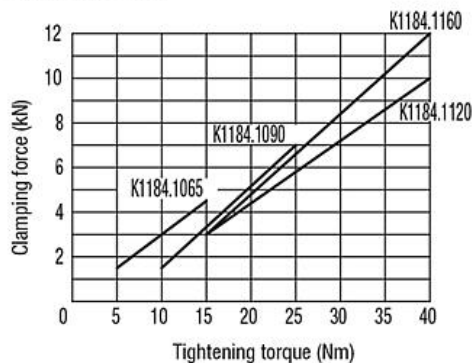

To avoid damaging the collet do not tighten the clamp without a workpiece or clamp ring. Observe the maximum tightening torque in the table.

Collets for external clamping

Overview of items

Collets for external clamping

Order No.	D	D1	D2	D3	D4	H	H1	H2	H3
K1184.1065	65	21	M8	M5	20	29	25	10	4
K1184.1090	90	25	M10	M6	24	40	35	15	5
K1184.1120	120	25	M10	M6	24	46	40	20	5
K1184.1160	160	29	M12	M8	28	52	45	25	6